



# **ANACONDA**

***WHERE TIMING AND CONVEYING MEET WITH PRECISION***

***QUIET  
FAST  
PRECISE***

***F.N. Sheppard & Co.***<sup>®</sup>  
*Belting Specialties*

# ANACONDA

**Anaconda is a patented new product created by F.N. Sheppard® for high-speed conveying applications where precision tracking is essential. Anaconda is both a synchronous belt and a conveyor belt in one!**

The unibody construction consists of an extruded urethane flat section and a offset helical drive section both reinforced with high strength Kevlar™ reinforcement. This homogeneous design not only provides precise low-noise indexing and accurate belt tracking, it also offers low-friction high-strength “wings” on either side of the drive teeth that glide smooth across your conveyor path using low energy.

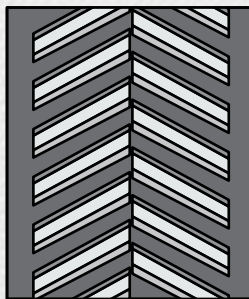

32mm



Comparison of the 32mm and 50mm

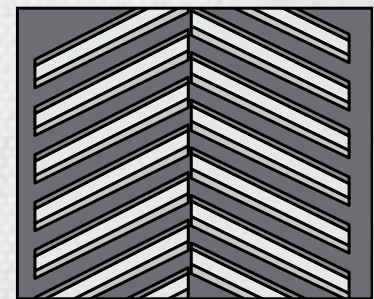

50mm

## WIDTH OPTIONS:

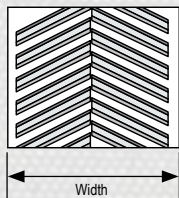

TRACK WIDTH (mm)	MAX BELT WIDTH (mm)
32	210
50	535

## INDUSTRIES:

Paper
Packaging
Material Handling

## QUIET RUNNING:

8mm offset helical pitch with gray poymide fabric on tooth side offers wear resistance and low noise.



## PULLEY DESIGN: DRIVE & DRIVEN PULLEYS

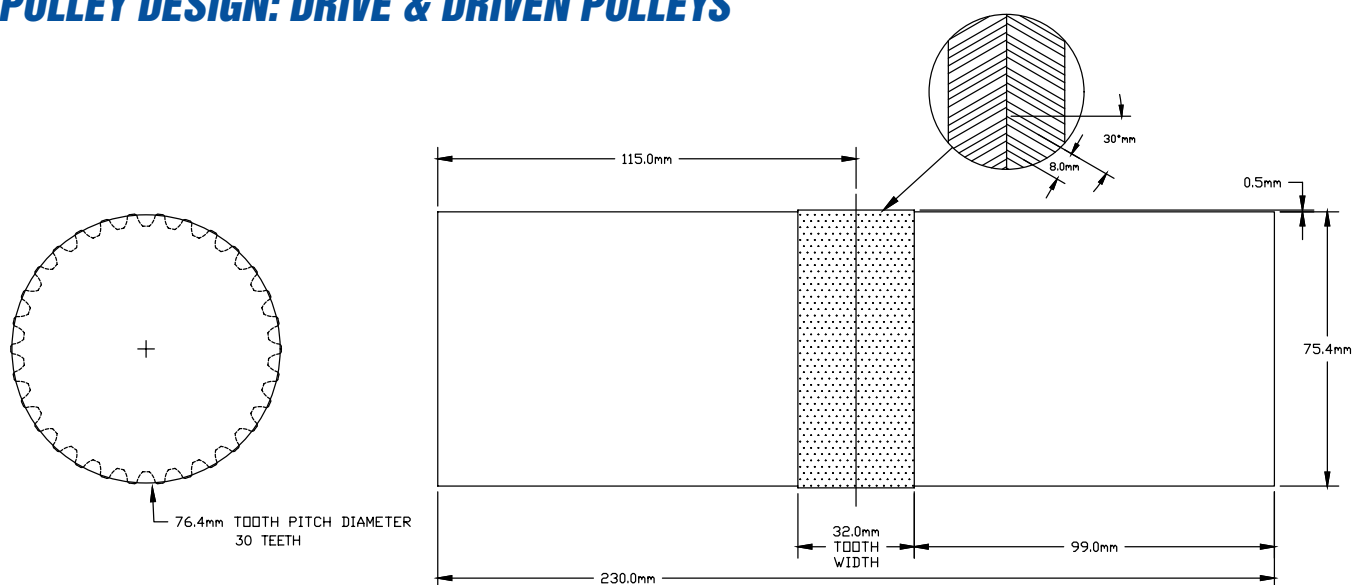

### BENEFITS OF ANACONDA:

- **QUIET RUNNING**
- **TRUE SELF TRACKING**
- **PRECISION INDEXING**
- **LOW INSTALLED TENSION**
- **NO SLIPPAGE ON DRIVE PULLEY**
- **LOW FRICTION ON WINGS**

### SPECIFICATIONS:

Belt Body	Thermoplastic Urethane - non FDA
Durometer	85 shore A
Cord Reinforcement	Kevlar™
Belt Drive Side - helical offset teeth	Gray polyamide fabric
Belt Drive Side - Wings - flat sections	Gray polyester fabric
Minimum Drive Pulley Diameter	60mm toothed
Minimum Driven Pulley Diameter	60mm - can be smooth, but deep groove (see sketch)
Max Operating Speed	2000 fpm

### COEFFICIENT OF FRICTION:

Anaconda wings against Steel	0.119
Anaconda wings against UHMW	0.130

# QUIET - FAST - PRECISE

**COVERS:**

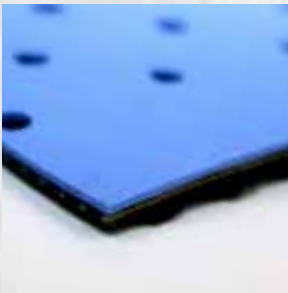

**SILICONE**

Non stick low or high COF. Multiple colors available. FDA Compliant compounds available as well as non-marking.



**HIGH GRIP**

High COF natural latex rubber with excellent abrasion resistance. Also shock and tear resistant.

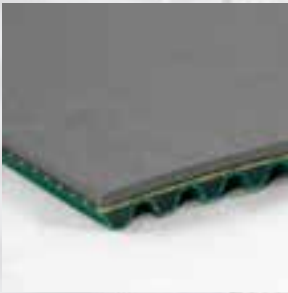

**RELEASE**

Release surface with high COF to prevent adhesive, labels, tape, etc. from sticking to the belt surface.



**DELICATE HANDLING**

Soft, compressible, flexible surface for delicate or soft products. Mixed cell structure.

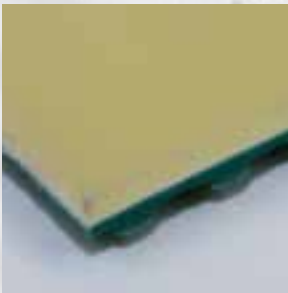

**STANDARD GRIP**

55A durometer PVC Blend for good COF and good abrasion resistance.



**CUSHIONING**

Firm, compressible flexible surface for cushioning or impact.



**MEDIUM GRIP**

40A durometer PVC Blend with High COF for excellent grip on difficult products to convey.



**CUSTOM MATERIALS**

Many options available for special handling, temperature resistance, chemical resistance, non-marking, texture, etc.



**LOW GRIP**

A low COF coating for accumulation and transverse loading where the product needs to slide on the belt surface.



**SPECIALTY SPONGE**

Resistance to low & high temperatures, -40°F to 300°F. Soft & resilient with good elasticity.

**COVER & BELT MODIFICATIONS:**



**HOLE SHAPE OPTIONS:**



Various vacuum hole patterns provide positive holding power for light products such as paper, plastic film and non-woven fabrics.

**STAGGERED HOLE:**

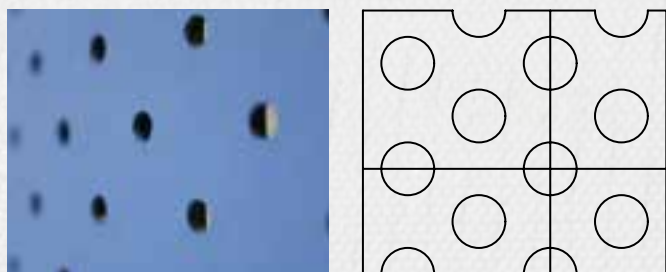

Hole size and pattern can be modified to meet the application demands. F.N. Sheppard has sophisticated perforating equipment to ensure accuracy and offer various shapes and patterns.

**SQUARE HOLE:**

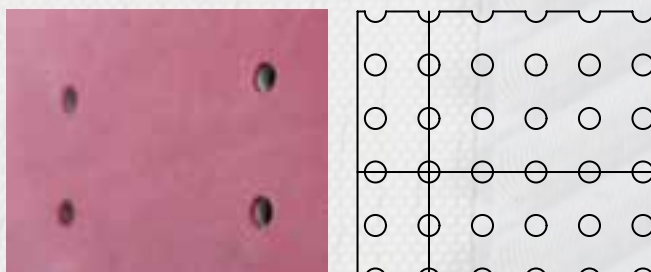

Standard patterns are available and holes can be perforated across entire belt with, including the tooth area.

**ADVANCED PROCESS:**



Contouring with slots, grooves or pockets can be accommodated. These special designs allow for better vacuum control of the product being conveyed.

F.N. Sheppard can machine any belt surface to precise tolerances. We can assist in designing the most effective belt for your application.

